

15 Degree Squedge Block

Spin your way into an amazing quilt with this 15 degree spinner. Check out the finishing options on page 4.

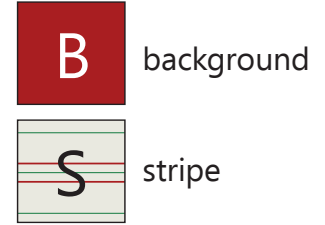
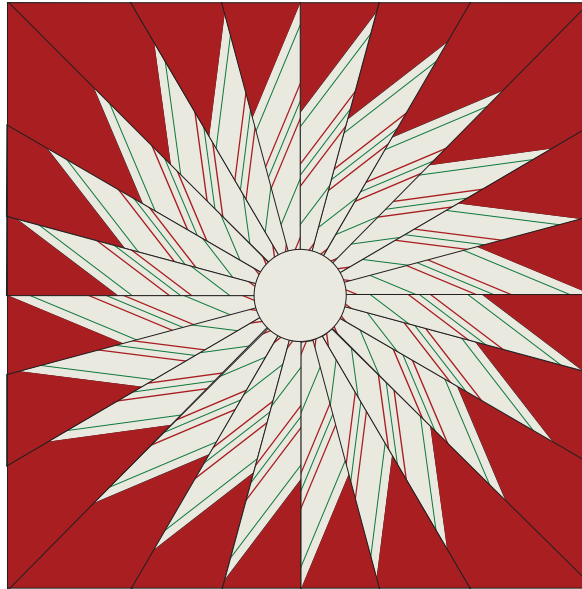

Finished block:
16 1/2" square

Fabric	Exact Amount	Suggested Yardage <i>for a stripe running perpendicular to the selvage or an all over design</i>	Suggested Yardage <i>for a stripe running parallel to the selvage</i>
B	15"	1/2 yd*	1 1/2 yd
S	12"	3/8 yd	1 1/2 yd

* May require more fabric depending on design repeats

Fabric	Number of Strips	Strip Width
B	two	3 1/2" x width of fabric
	one	4 1/2" x width of fabric
S	three	3 1/4" x width of fabric

To get exact matches with your striped points, be sure you cut identical strips from the striped fabric.

Tool Preparation

Apply adhesive non-slip rings to both the back and front side of the tool. You need to have these on both sides as you'll be cutting pieces with the tool flipped over.

On the back side of the tool place a strip of pink glow tape on the 30 degree line as shown.

Place a strip of yellow tape on the opposite 30 degree line.

Using this tape has helped me keep the cuts straight. We'll continue to use these markings on the next few month's blocks. You can find the glow tape at many quilt shops and online stores, including mine.

Notice the little slots in the tool? This is how you'll know where to cut the shorter *Squedge* pieces. Use a mechanical pencil to mark a line in each slot onto the fabric. Cut around the other sides of the tool, then remove the tool. Using a straight edge (or the outside edge of this tool) connect the marked lines and cut across the bottom of the *Squedge* piece.

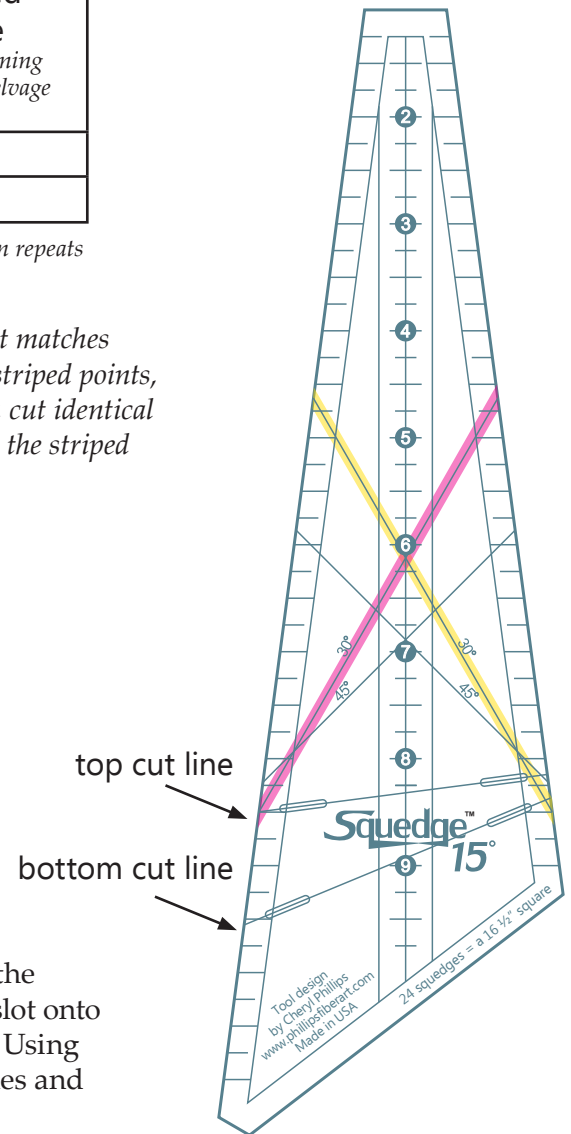

Helpful labels for the strip sets are found on page 5.

Place the tool on the strip set so the **pink** 30 degree line is aligned with the seam.

The words on the tool are **UP**.

Cut the *full* tool shape.

Relabel the remainder of Set 1 as Set 3

Place the tool on the strip set so the **yellow** 30 degree line is aligned with the seam.

The words on the tool are **DOWN**.

Cut the *full* tool shape.

Relabel the remainder of Set 2 as Set 4

Place the tool on the strip set so the **pink** 30 degree line is aligned with the seam.

The words on the tool are **UP**.

Cut the *partial* tool shape using bottom cut line.

Place the tool on the strip set so the **yellow** 30 degree line is aligned with the seam.

The words on the tool are **DOWN**.

Cut the *partial* tool shape using bottom cut line.

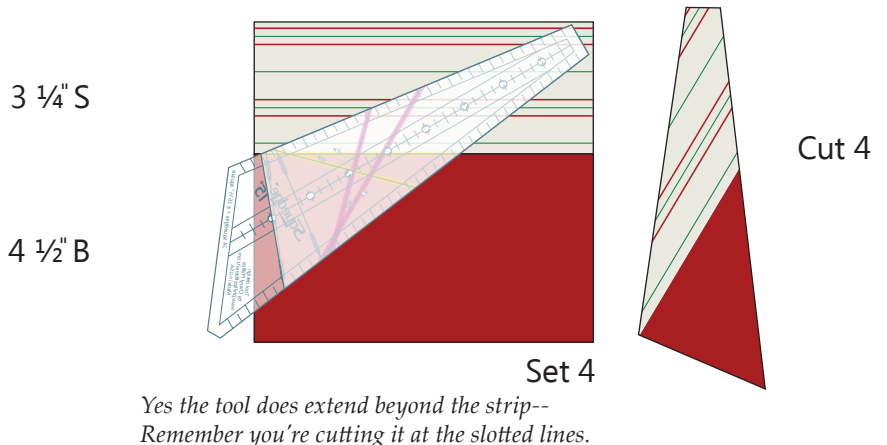
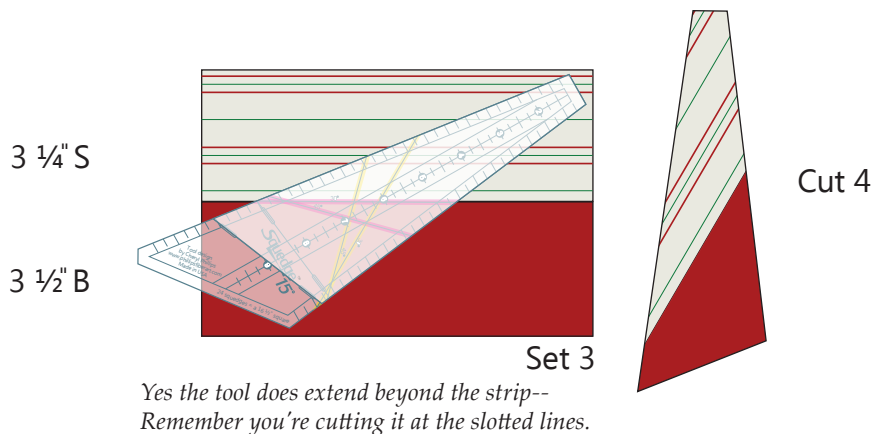
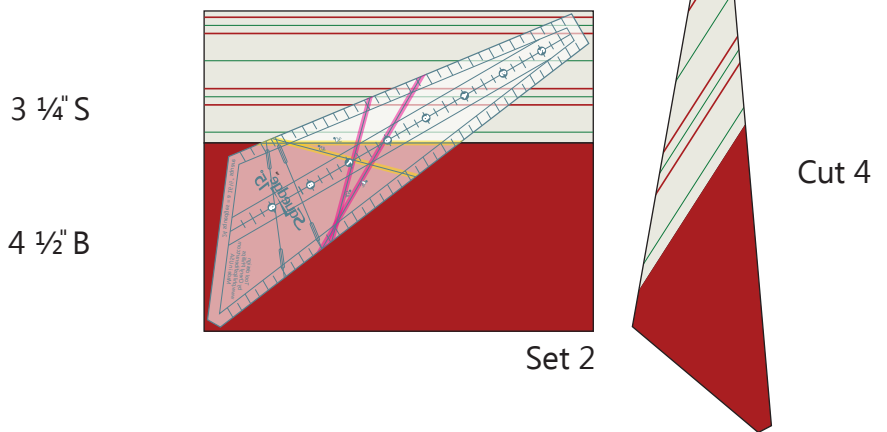
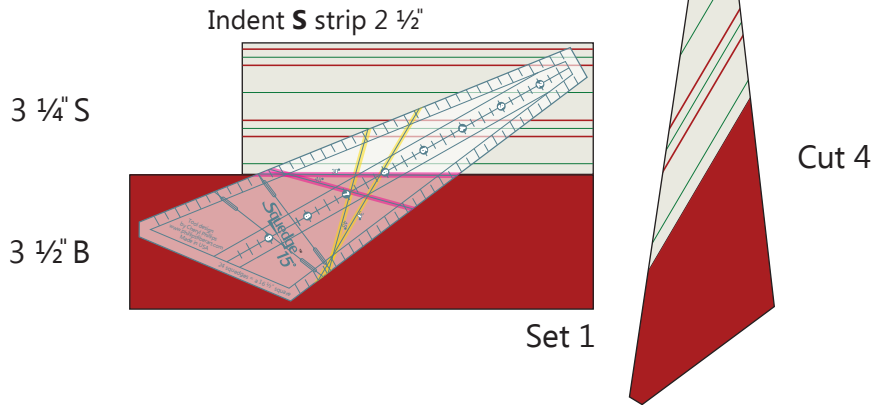

Place the tool on the strip set so the **pink** 30 degree line is aligned with the seam.

The words on the tool are **UP**.

Cut the *partial* tool shape using top cut line.

Relabel the remainder of Set 5 as Set 6.

Place the tool on the strip set so the **yellow** 30 degree line is aligned with the seam.

The words on the tool are **DOWN**.

Cut the *partial* tool shape using top cut line.

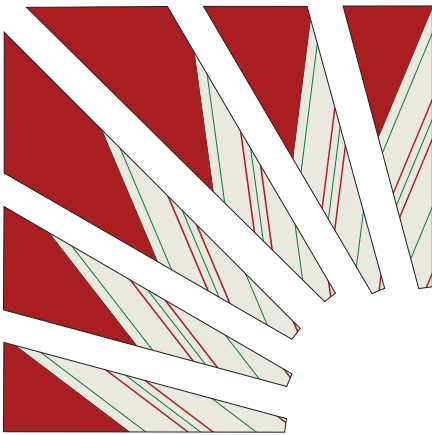
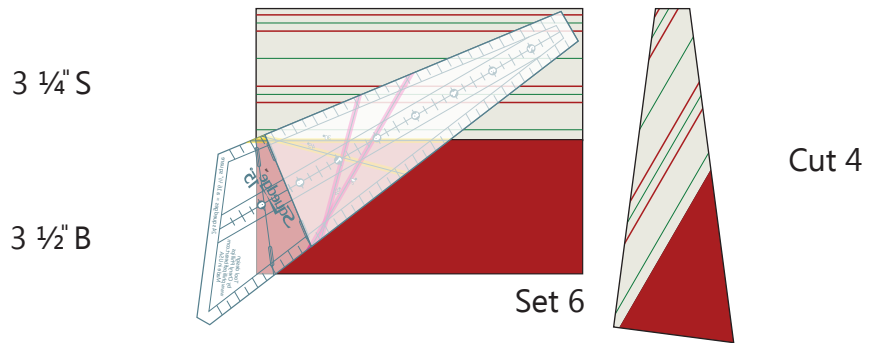
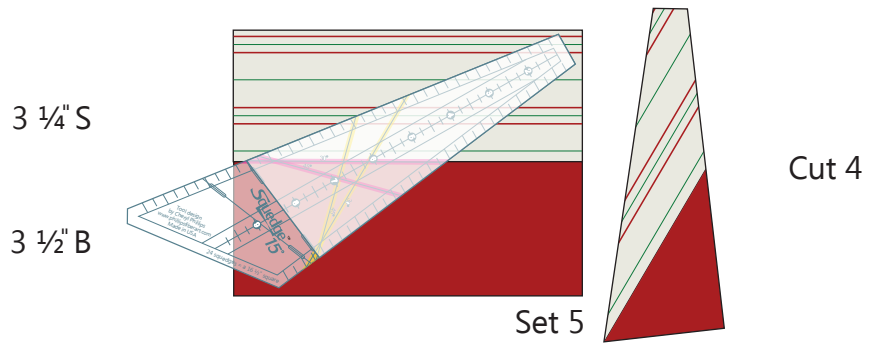

Arrange the pieces as shown.
Sew four together to make a quarter square.
Sew the four quarter squares together to make the block.

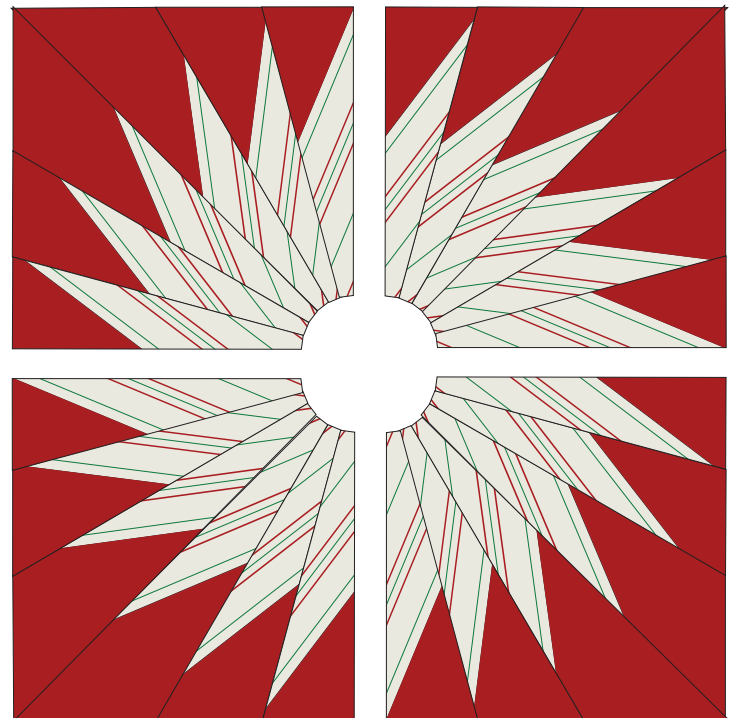

Iron a square of freezer paper to the back of the project to stabilize the center opening.

Trace a circle onto freezer paper.

Iron the freezer paper onto a scrap of fabric you've chosen for your center applique.

Cut the fabric, allowing ¼" for turning under.

Applique the circle to the center opening.

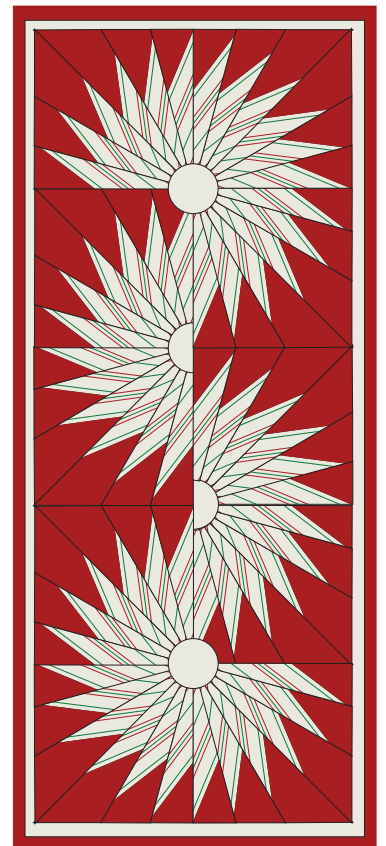
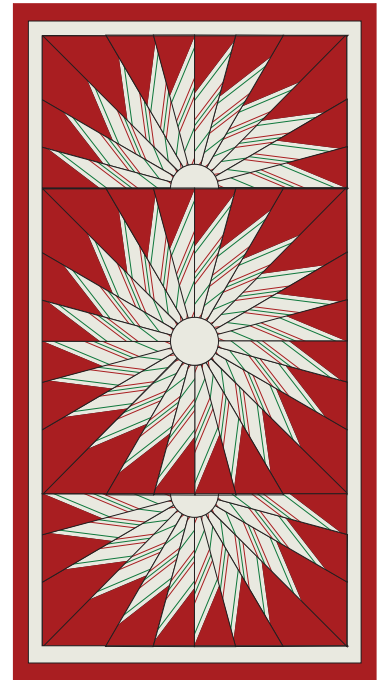
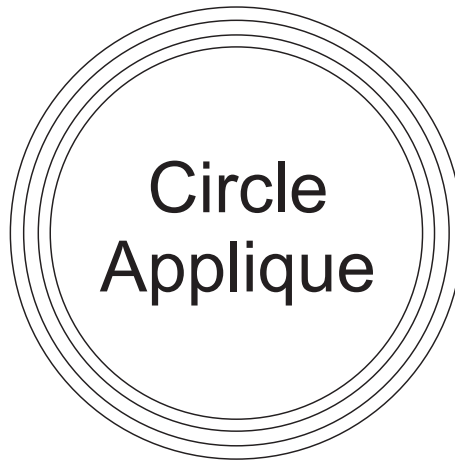
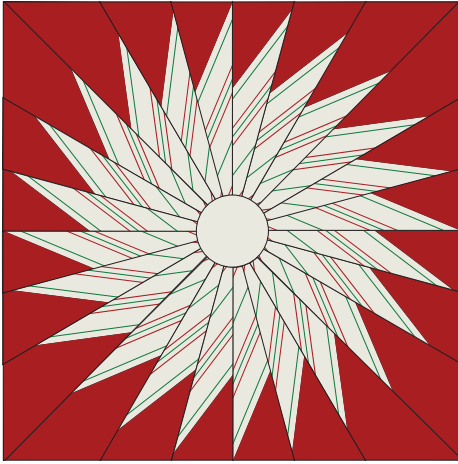

Options For Finishing

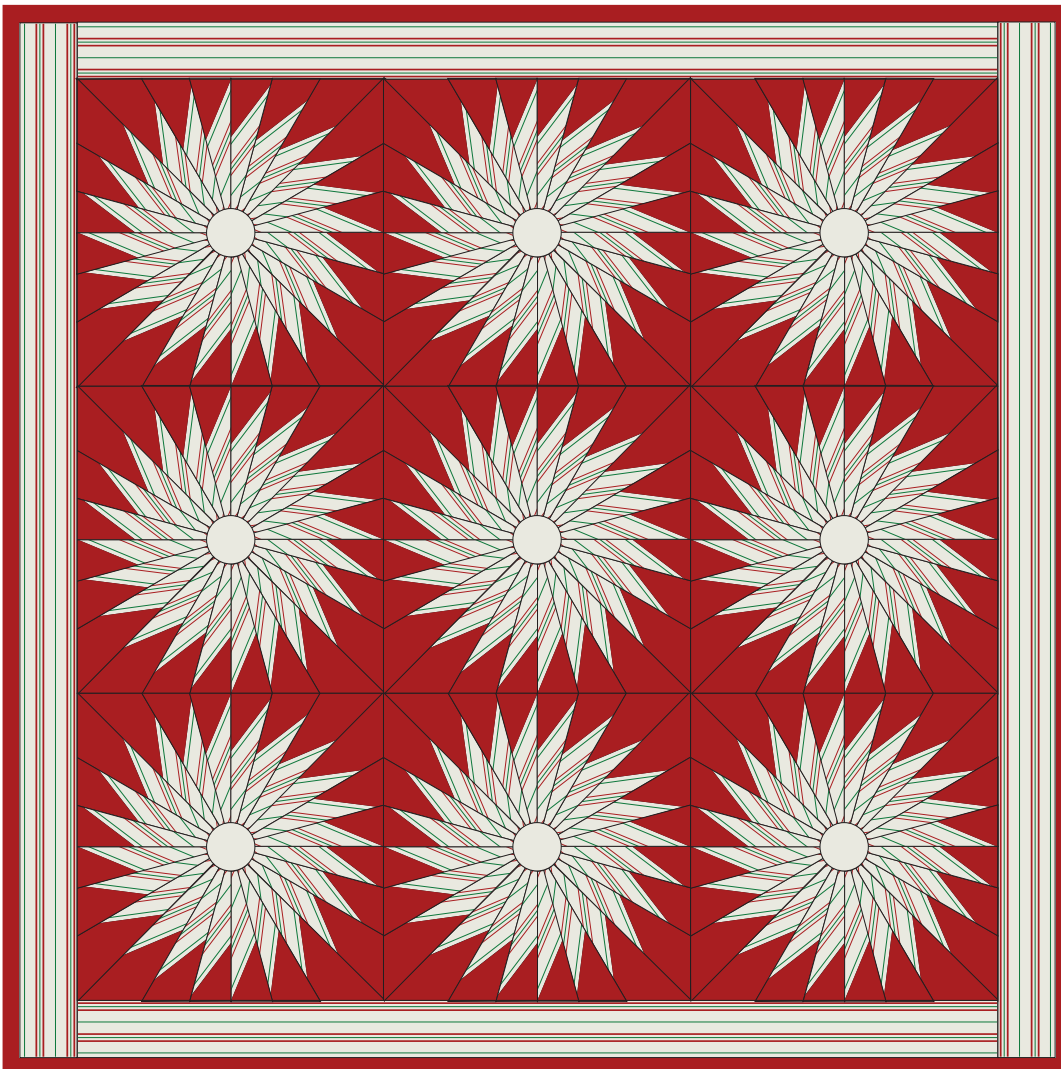

Sample made with 15 Degree Squedge blocks

Table Runner

Set #1

3 1/4" S 3 1/2" B

Use **pink** 30 degree line
with words facing **UP**

Cut 4 full wedges

Set #2

3 1/4" S 4 1/2" B

Use **yellow** 30 degree line
with words facing **DOWN**

Cut 4 full wedges

Set #3

remainder of Set 1

3 1/4" S 3 1/2" B

Use **pink** 30 degree line
with words facing **UP**

Cut 4 partial wedges using bottom cut line

Set #4

remainder of Set 2

3 1/4" S 4 1/2" B

Use **yellow** 30 degree line
with words facing **DOWN**

Cut 4 partial wedges using bottom cut line

Set #5

3 1/4" S 3 1/2" B

Use **pink** 30 degree line
with words facing **UP**

Cut 4 partial wedges using top cut line

Set #6

remainder of Set 5

3 1/4" S 3 1/2" B

Use **yellow** 30 degree line
with words facing **DOWN**

Cut 4 partial wedges using top cut line